

Programmable DC Power Supply

IT6900 Series User Manual

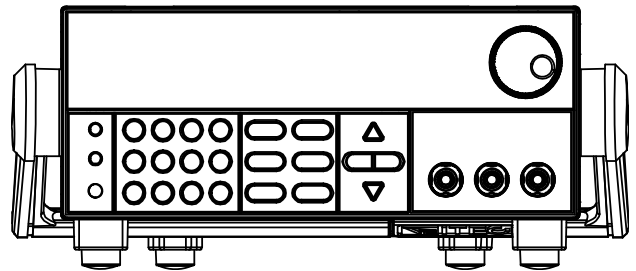

Model: IT6922A/IT6932A/IT6933A/IT6942A/
IT6952A/IT6953A/IT6922B/
IT6932B/IT6942B/IT6952B/IT6953B

Version: V2.0

Statement

© Itech Electronic, Co., Ltd. 2018
No part of this manual may be reproduced in any form or by any means (including electronic storage and retrieval or translation into a foreign language) without prior permission and written consent from Itech Electronic, Co., Ltd. as governed by international copyright laws.

Manual Article No.

IT6900-402178

Revision

Revision 2, published on

Aug. 31st 2018

Itech Electronic, Co., Ltd.

Trademark Statement

Pentium is a registered trademark of Intel Corporation in the United States.

Microsoft, Visual Studio, Windows and MS Windows are trademarks of Microsoft Corporation in the United States and/or other countries/regions.

Guarantee

Materials in the document are provided *talīs qualīs* and may be changed in future revisions without prior notice. In addition, within the maximum allowable extent of laws, ITECH is not committed to any explicit or implied guarantee for this manual and all information therein, including but not limited to the implied guarantee on marketability and availability for some special purposes. ITECH shall not be responsible for any error or incidental or indirect losses caused by the provision, use or application of this documents and information therein. If some guarantee clauses in other written agreements between ITECH and users are not consistent with clauses herein, those clauses in other written agreements shall prevail.

Technology license

Hardware and/or software in this document cannot be provided without a license and can only be used or copied according to the license.

Restricted permission statement

Restricted permissions of the U.S. government. Permissions for software and technical data which are authorized to the U.S. Government only include those for custom provision to end users. ITECH follows FAR 12.211 (technical data), 12.212 (computer software). DFARS 252.227-7015 (technical data--commercial products) for national defense and DFARS 227.7202-3 (permissions for commercial computer software or computer software documents) while providing the customized business licenses of software and technical data.

Safety Statement

CAUTION

“Caution” signs indicate danger. It is required to pay attention to the contents of these signs during implementation of operations.

The damage to the product or loss of important data may be caused in case of improper operation steps or failure to follow operation steps. Do not continue to implement any improper operation indicated in “Caution” signs when the specified conditions are not fully understood or these conditions are not satisfied.

WARNING

“Warning” indicates danger. It is required to pay attention to the contents of these signs during implementation of operation steps. Personal casualties may be caused in case of improper operation steps or failure to follow these operation steps. Do not continue to implement any improper operation indicated in “Warning” signs when the specified conditions are not fully understood or these conditions are not satisfied.



Note

“Instructions” indicates operation instructions. It is required to refer to the contents of these signs during operation steps. These signs are used for providing tips or supplementary information for operators.

Certification and Quality Assurance

IT6900 series power supply completely reaches nominal technical indicators in the manual.

Warranty Service

ITECH Company will provide one-year warranty services for the product materials and manufacturing (excluding the following limitations).











- When warranty service or repair is needed, please send the product to the service unit specified by ITECH Company.
- When the product is sent to ITECH Company for warranty service, the customer must pay the one-way freight to the maintenance department of ITECH, and ITECH will be responsible for return freight.
- If the product is sent to ITECH for warranty service from other countries, the customer will be responsible for all the freight, duties and other taxes.



Limitation of Warranty

This Warranty will be rendered invalid in case of the following:

- Damage caused by circuit installed by customer or using customer own products or accessories;
- Product which has been modified or repaired by the customer;
- Damage caused by circuit installed by customer or not operating our products under designated environment;
- The product model or serial number is altered, deleted, removed or made illegible by customer;
- Damage caused by accidents, including but not limited to lightning, water, fire, abuse or negligence.

Safety Signs

	Direct current		ON (power)
	Alternating current		OFF (power)
	Both direct and alternating current		Power-on state
	Protective earth (ground) terminal		Power-off state
	Earth (ground) terminal		Reference terminal

	Caution	+	Positive terminal
	Warning (refer to this manual for specific Warning or Caution information)	—	Negative terminal
	A chassis terminal	-	-

Safety Precautions

General safety precautions below must be followed in each phase of instrument operation. In case of failure to follow these precautions or specific warnings in other parts of the manual, violation against the safety standards related to the design, manufacture and purpose of the instrument will occur. If the user does not follow these precautions, ITECH will bear no responsibility arising there from.

WARNING

- The power supply is provided with a three-core power cord during delivery and should be connected to a three-core junction box. Before operation, be sure that the power supply is well grounded.
- Use electric wires of appropriate load. All loading wires should be capable of bearing maximum short-circuit of electronic load without overheating.
- Ensure the voltage fluctuation of mains supply is less than 10% of the working voltage range in order to reduce risks of fire and electric shock.
- To prevent burnout, please pay special attention to positive and negative polarities of power supply during connection!
- Do not use damaged equipment. Please check the housing before using the equipment. Check whether the instrument is subject to cracking or is lack of plastic. Do not operate the instrument in the environment with explosive gas, steam or dust.
- Observe all tags on the equipment before connection.
- Do not install alternative parts on the instrument or perform any unauthorized modification.
- Do not use the equipment when the removable cover is dismantled or loose.
- Please use the power adapter supplied by the manufacturer to avoid accidental injury.
- We do not accept responsibility for any direct or indirect financial damage or loss of profit that might occur when using the instrument.
- This instrument is used for industrial purposes. Do not apply this product to IT power supply system.
- Do not use the equipment on the life support system or other equipment with safety requirements.

CAUTION

- If the equipment is not used in the manner specified by the manufacturer, its protection may be damaged.
- Always use dry cloth to clean the equipment housing. Do not clean the inside of the instrument.
- Do not block the air vent of the equipment.

Environmental Conditions

The IT6900 series power supply can only be used indoors or in low condensation areas. The following table shows general environmental requirements for this instrument.



Environmental conditions	Requirement
Operating temperature	0°C - 40°C
Operating humidity	20% - 80% (non condensing)
Storage temperature	-20°C - 70 °C
Altitude	Operating up to 2,000 meters
Pollution	Grade 2 pollution
Installation category	II



Note

To make accurate measurements, allow the instrument to warm up for 30 min before operation.

Regulation Tag

	The CE mark indicates that the product complies with all the relevant European legal directives. The specific year (if any) affixed refers to the year when the design was approved.
	The instrument complies with the WEEE Directive (2002/96/EC) marking requirement. This affixed product label indicates that you must not discard the electrical/electronic product in domestic household waste.

	<p>This symbol indicates the time period during which no hazardous or toxic substances are expected to leak or deteriorate during normal use. The expected service life of the product is 10 years. The product can be used safely during the 10-year Environment Friendly Use Period (EFUP). Upon expiration of the EFUP, the product must be immediately recycled.</p>
---	--

Waste Electrical and Electronic Equipment (WEEE)

Directive



Waste electrical and electronic equipment (WEEE) directive, 2002/96/EC

The product complies with tag requirements of the WEEE directive (2002/96/EC). This tag indicates that the electronic equipment cannot be disposed of as ordinary household waste.

Product Category

According to the equipment classification in Annex I of the WEEE directive, this instrument belongs to the "Monitoring" product.

If you want to return the unnecessary instrument, please contact the nearest sales office of ITECH.

Compliance Information

Complies with the essential requirements of the following applicable European Directives, and carries the CE marking accordingly:

- Electromagnetic Compatibility (EMC) Directive 2014/30/EU
- Low-Voltage Directive (Safety) 2014/35/EU

Conforms with the following product standards:

EMC Standard

IEC 61326-1:2012/ EN 61326-1:2013 ¹²³

Reference Standards

CISPR 11:2009+A1:2010/ EN 55011:2009+A1:2010 (Group 1, Class A)

IEC 61000-4-2:2008/ EN 61000-4-2:2009

IEC 61000-4-3:2006+A1:2007+A2:2010/ EN 61000-4-3:2006+A1:2008+A2:2010

IEC 61000-4-4:2004+A1:2010/ EN 61000-4-4:2004+A1:2010

IEC 61000-4-5:2005/ EN 61000-4-5:2006

IEC 61000-4-6:2008/ EN 61000-4-6:2009

IEC 61000-4-11:2004/ EN 61000-4-11:2004

1. The product is intended for use in non-residential/non-domestic environments. Use of the product in residential/domestic environments may cause electromagnetic interference.
2. Connection of the instrument to a test object may produce radiations beyond the specified limit.
3. Use high-performance shielded interface cable to ensure conformity with the EMC standards listed above.

Safety Standard

IEC 61010-1:2010/ EN 61010-1:2010

Content

Certification and Quality Assurance	i
Warranty Service	i
Limitation of Warranty	i
Safety Signs.....	i
Safety Precautions	ii
Environmental Conditions.....	iii
Regulation Tag.....	iii
Waste Electrical and Electronic Equipment (WEEE) Directive.....	iv
Compliance Information.....	v
Chapter1 Inspection and Installation	1
1.1 Verifying the Shipment.....	1
1.2 Instrument Size Introduction.....	1
1.3 Rack Mounting.....	3
1.4 Connecting the Power Cord	3
Chapter2 Quick Start.....	5
2.1 Brief Introduction	5
2.2 Introduction to front panel.....	6
2.3 Key introduction	7
2.4 VFD Description	7
2.5 Introduction to rear panel.....	8
2.6 Power-on self-test.....	10
Chapter3 Function and Features	13
3.1 Local/Remote Mode	13
3.2 Voltage Setup	13
3.3 Current Setup	13
3.4 On/Off Operation	14
3.5 Setup value/Actual value	14
3.6 Voltage/Current/Power adjustment.....	14
3.7 Saving Operation	14
3.8 Trigger operation	15
3.9 Menu operation.....	15
3.10 OVP Function	23
3.11 Key Lock	23
3.12 Rear pins function.....	24
3.12.1 Remote sense and DVM terminals.....	24
3.12.2 RS485 and Output Sync signal interface.....	25
3.13 Analog control interface	26
Chapter4 Remote Operation Mode	27
4.1 RS232 interface	27
4.2 USB interface	29
4.3 GPIB interface	29
4.4 RS485 interface	29

Chapter5	Technical Specification	31
5.1	Major Technical Parameters	31
5.2	Supplemental Characteristics.....	36
Appendix	37
	Specifications of Red and Black Test Lines.....	37

Chapter1 Inspection and Installation

1.1 Verifying the Shipment

Unpack the box and check the contents before operating the instrument. If wrong items have been delivered, if items are missing, or if there is a defect with the appearance of the items, contact the dealer from which you purchased the instrument immediately. The package contents include:

Checklist of Package Contents

Item	Qty.	Model	Remarks
IT6900 power supply	x1	IT6900 series	The IT6900 series include: IT6922A/IT6932A/IT6933A/ IT6942A/IT6952A/IT6953A/ IT6922B/IT6932B/IT6942B/ IT6952B/IT6953B
Power cord	x1	IT-E171/IT-E172 /IT-E173/IT-E174	User may select an appropriate power cord that matches the specifications of power socket used in the area. See the Section Connecting the Power Cord for details.
USB cable	x1	-	-
Ex-factory Test Report	x1	-	It is the test report of the instrument before delivery.



NOTE

After confirming that package contents are consistent and correct, please appropriately keep package box and related contents. The package requirements should be met when the instrument is returned to factory for repair.

IT6900 series power supply is supplied with the following optional accessories (sold separately):

Item	Model	Remarks
IT-E151A (Rack mount kit)	IT-E151A	To mount the instrument on a special rack, user may select this optional.

1.2 Instrument Size Introduction

The instrument should be installed at well-ventilated and rational-sized space.

Please select appropriate space for installation based on the electronic load size.

IT6900 series power supply different models are not the same size, the detail size of the power supply is shown as below.

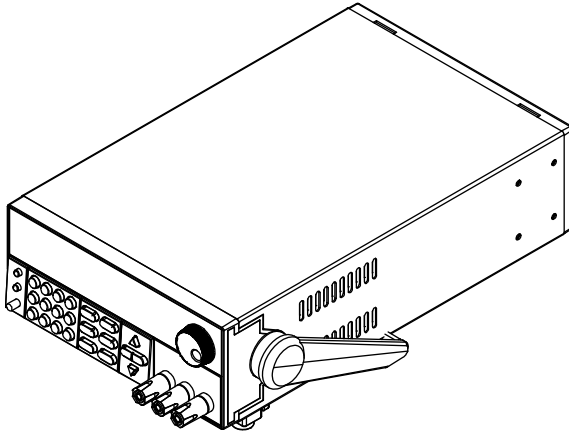
IT6922A/IT6932A/IT6933A/IT6942A/IT6922B/IT6932B/IT6942B Models

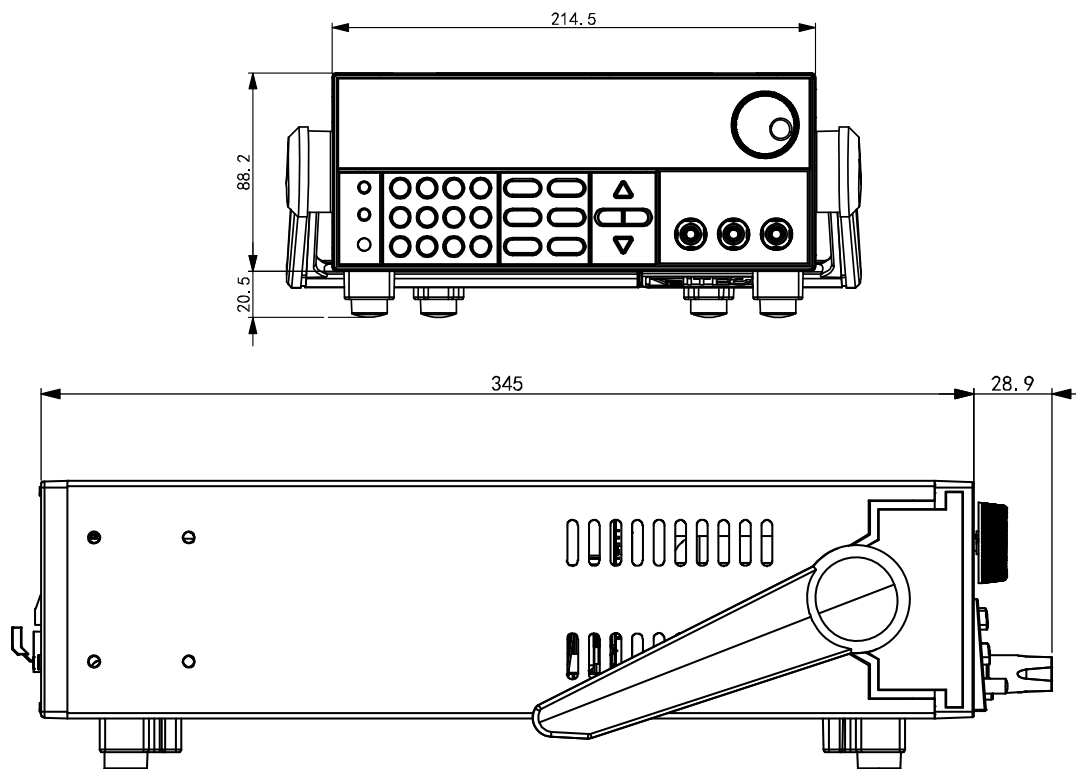
Detailed Dimension Drawing

IT6952A/IT6953A/IT6952B/IT6953B Models

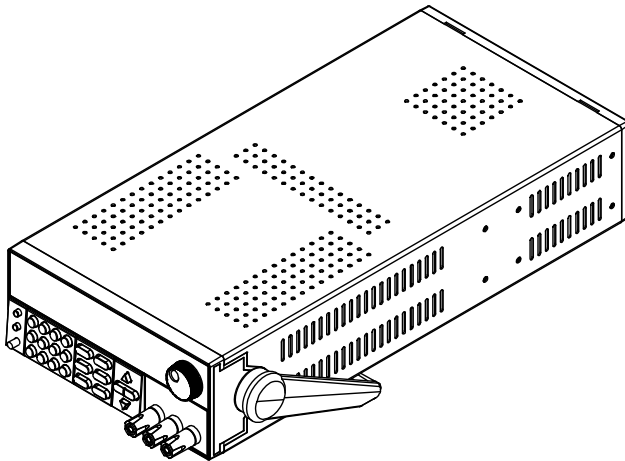

Detailed Dimension Drawing

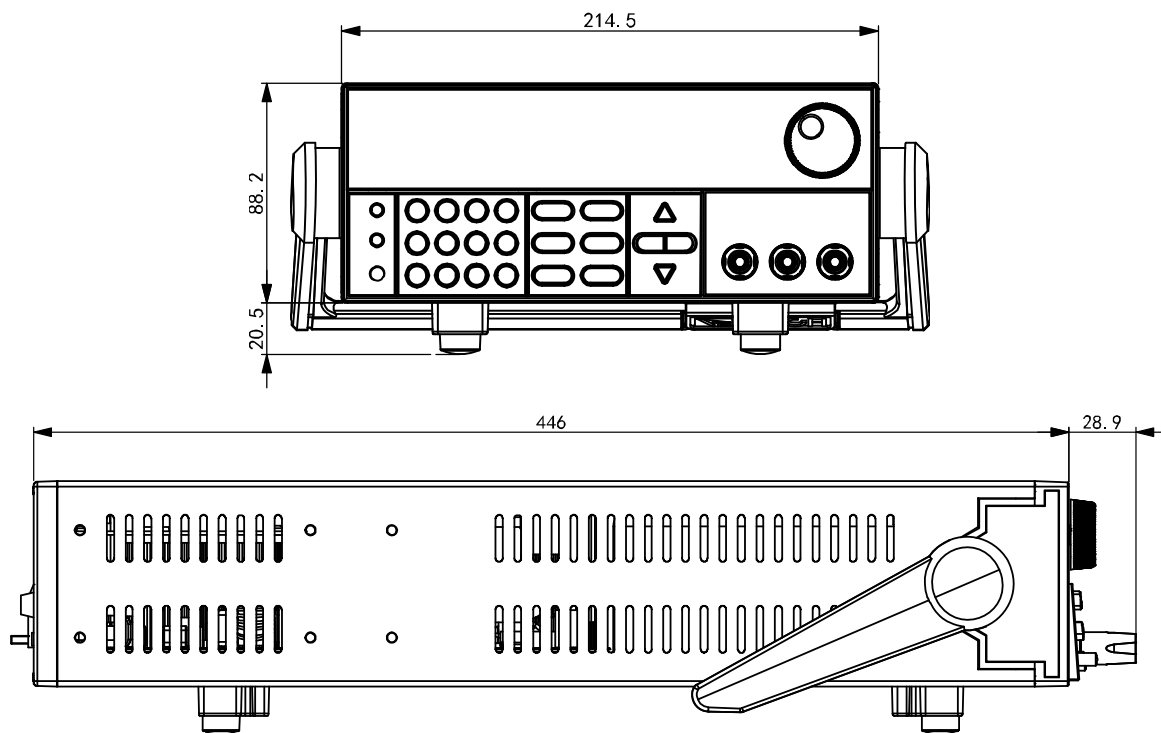

1.3 Rack Mounting

IT6900 series power supply can be mounted on a standard 19" rack. ITECH provides user with IT-E151A rack, an optional mount kit.

1.4 Connecting the Power Cord

Connect power cord of standard accessories and ensure that the power is under normal power supply.

AC power input level

Working voltage of IT6900 series includes 110V and 220V (which can be selected by the switch at the bottom of power supply).

AC power input level:

- Option Opt.01: 220VAC \pm 10%, 47 to 63 Hz
- Option Opt.02: 110 VAC \pm 10%, 47 to 63 Hz

Categories of power lines

Select from the flowing schedule of power cord specifications an appropriate power cord that matches the voltage for the area in which you use the instrument. If the power cord included in the instrument you purchased does not match the voltage, contact the dealer or manufacturer for change.

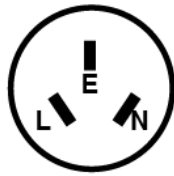

China
IT-E171



United States &
Canada & Japan
IT-E172

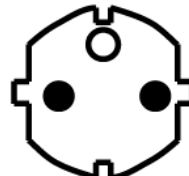

Europe
IT-E173



England
IT-E174

Chapter2 Quick Start

This chapter introduces the front panel, the rear panel, key functions and VFD display function of the power supply, make sure that you can quickly know the appearance, instruction and the key function before you operate the power supply. Help you make better use of this series of power supply.

2.1 Brief Introduction

IT6900 series power supplies are high performance single-output programmable DC power supplied with communication interface. This series of programmable DC power supply can output the maximum voltage or current with a fixed power for customers. Take IT6922A (60V/5A/100W) for example, when you select 60V for the output voltage, the output power of IT6922A is 100W, so in this case the maximum output current is $100W/60V = 1.66A$. When you select 20V for the output voltage, the maximum output current $100W/20V = 5A$, but when the output voltage is down to 10V, due to IT6922A maximum current is 5A, so in this case the maximum output current is 5A. IT6900 series power comes with a standard communication interface RS232/USB/GPIB/RS485, both desktop and system-based features, can be designed and tested according to your needs and provide multi-purpose solutions.

Convenient bench-top features:

- High visibility vacuum fluorescent display (VFD)
- Digital keyboard operation
- High accuracy and high resolution
- Low ripple and low noise
- Intelligent fan control, energy conservation, noise reduction
- Standard communication interface RS232/USB/GPIB/RS485
- Can be monitored by computer software
- Output voltage and current values accordance with procedure
- Can use the knob to adjust the voltage and current
- Can adjust the numbers steps using the cursor
- Rich SCPI orders to facilitate the formation of intelligent test platform
- Can set the output timer (0.1 ~ 99999.9s)
- External Analog Control Interface

Model	Voltage	Current	Power
IT6922A	60V	5A	100W
IT6932A	60V	10A	200W

IT6933A	150V	5A	200W
IT6942A	60V	15A	360W
IT6952A	60V	25A	600W
IT6953A	150V	10A	600W
IT6922B	60V	5A	100W
IT6932B	60V	10A	200W
IT6942B	60V	15A	360W
IT6952B	60V	25A	600W
IT6953B	150V	10A	600W

*IT6922B/IT6932B/IT6942B/IT6952B/IT6953B have standard RS485 communication interface and external Analog control Interface.

2.2 Introduction to Front Panel

The front panel of IT6900 series is shown in the next figure.

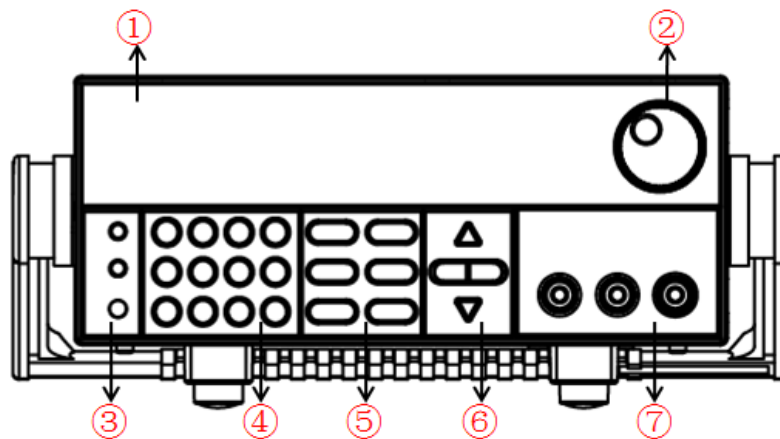





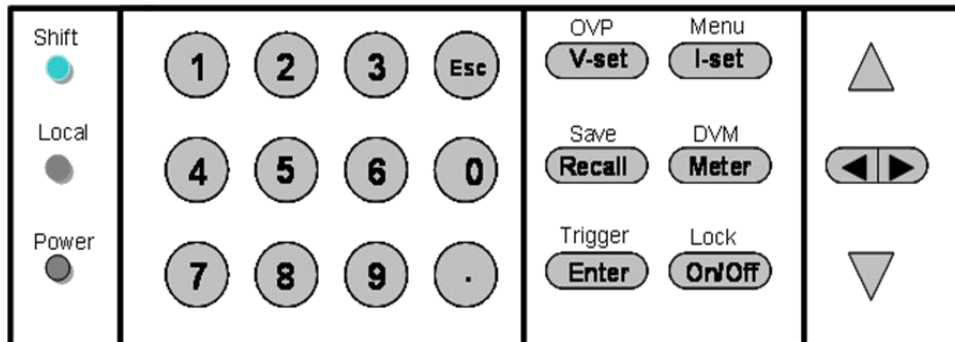







1. VFD display
2. Rotary knob
3. Compound key, the local switch key and power switch
4. Number keys and ESC
5. Function keys
6. UP/DOWN/LEFT and RIGHT key, to move cursor
7. Output terminals

2.3 Key Introduction



Key description, see the table below:

Keys	Name and the function
 (Shift)	Compound key, co-work with OVP, Menu, Save, DVM, Trigger, Lock
 (Local)	Local switch key, switch from remote mode to local operation mode.
 (Power)	Power on key
0-9	Numeric keys
.	Decimal point
 /OVP	Voltage set key, set the output voltage/over voltage protection point for the power supply.
 /Menu	Current set key, set the output current/menu function key, to set the relevant Parameters for the power supply.
 /Save	Callback key to call up a set value of system parameters already stored / storage key, to save system parameter settings.
 /DVM	Meter key, to switch from value set panel and the actual output value display / voltage meter function keys, to switch to the measure state of the voltage meter.
 /Trigger	Enter key, to confirm the number entered and operation / trigger button, which is used to trigger the List test.
 /Lock	Output on (off) keys, control power output state / keypad lock function keys, used to lock the panel buttons.
	Left and right movement keys, used to set the value, to adjust the cursor to the specified location.
	Up and down keys, used to select a item in the menu or increase (decrease) the output voltage or current values.
	Cancel /return keys.

2.4 VFD Description

Char	Function description	Char	Function description
OFF	Output is off	Timer	Output on timer function is ON
CV	The power supply is in constant voltage mode	Sense	No
CC	The power supply is in constant current mode	Ext	No
*	No	Adrs	(USB GPIB) light when the address match or (RS232) received order
Meter	"Meter" on state	Rmt	The power supply is in remote mode
Shift	Use compound keys	Error	The power supply has error or fault
OVP	OVP function state on	Prot	OVP OTP Protection
OCP	No	Lock	Key operation is locked by Password

2.5 Introduction to Rear Panel

- The rear panel of IT6922A/IT6932A/IT6933A/IT6942A is shown in the next figure.

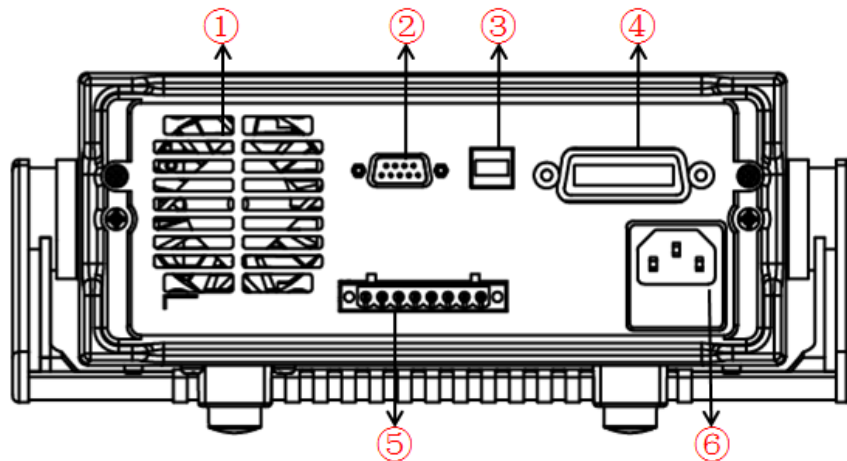

1. Cooling window
2. RS232 Communication cable interface
3. USB Communication cable interface
4. GPIB Communication cable interface
5. DVM input terminal, Remote measurement terminal and the output terminal
6. AC power socket(fuse contained)

- The rear panel of IT6952A/IT6953A is shown in the next figure.

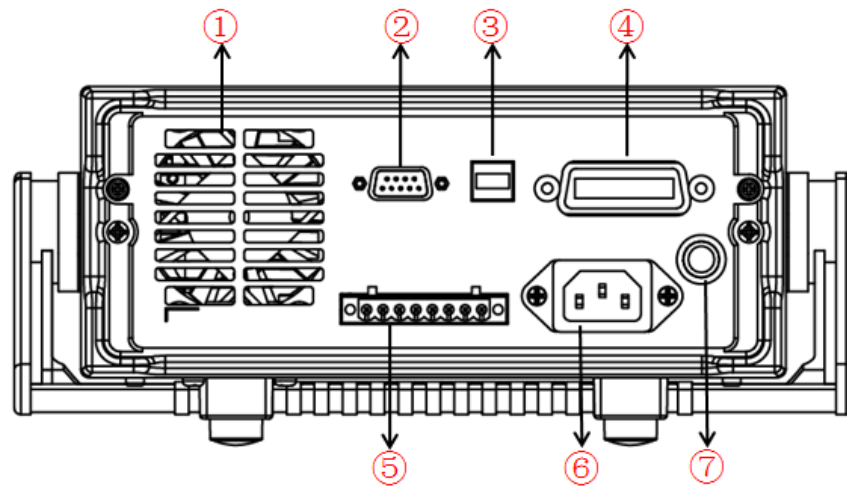

1. Cooling window
2. RS232 Communication cable interface
3. USB Communication cable interface
4. GPIB Communication cable interface
5. DVM input terminal, Remote measurement terminal and the output terminal
6. AC power socket
7. Fuse

- The rear panel of IT6922B/IT6932B/IT6942B is shown in the next figure.

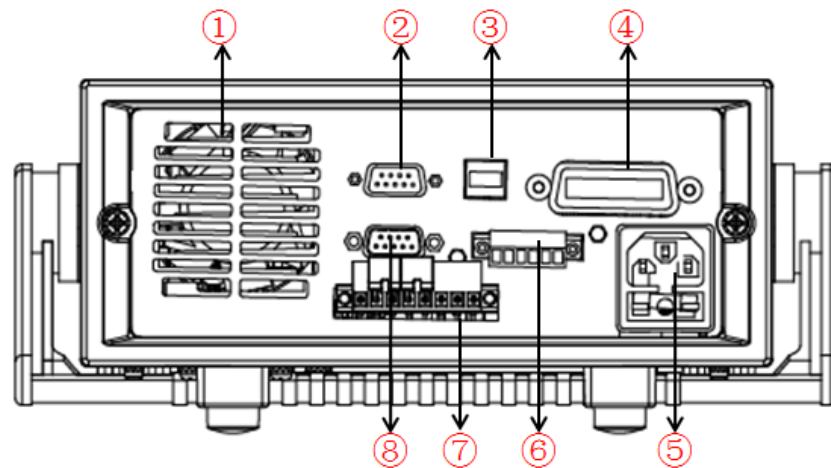

1. Cooling window
2. RS232 Communication cable interface
3. USB Communication cable interface
4. GPIB Communication cable interface
5. AC power socket(fuse contained)
6. Output Sync signal interface and RS485 Communication cable interface
7. DVM input terminal, Remote measurement terminal and the output terminal
8. Analog control interface

- The rear panel of IT6952B/IT6953B is shown in the next figure.

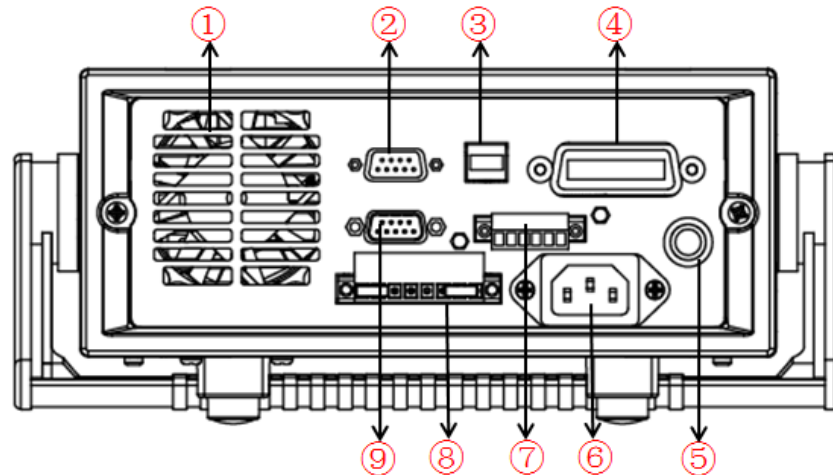

1. Cooling window
2. RS232 Communication cable interface
3. USB Communication cable interface
4. GPIB Communication cable interface
5. Fuse
6. AC power socket
7. Output Sync signal interface and RS485 Communication cable interface
8. DVM input terminal, Remote measurement terminal and the output terminal
9. Analog control interface

2.6 Power-on Self-test

A successful self-test indicates that the purchased power product meets delivery standards and is available for normal usage.

Before operation, please confirm that you have fully understood the safety instructions.

WARNING

- To avoid burning out, be sure to confirm that power voltage matches with supply voltage.
- Be sure to connect the main power socket to the power outlet of protective grounding. Do not use terminal board without protective grounding. Before operation, be sure that the power supply is well grounded.
- To avoid burning out, pay attention to marks of positive and negative polarities before wiring.

Self-test steps

Normal self-test procedures:

1. Correctly connect the power cord. Press **Power** key to start up.
2. After self-test, if the power supply is normal, then VFD will display the output voltage and current status as below:

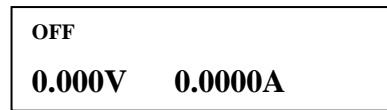

Error Information References

The following error information may occur when an error occurs during Power On self-test:

- If the EEPROM was damaged or the latest operation data in EEPROM was lost, the VFD will display “EEPROM FAIL”.
- If the last power status in EEPROM is lost, then the VFD will display “SYST LOST”.
- If the calibration data in EEPROM is lost, the VFD display the tooltip information “CAL LOST”.
- If the factory calibration data in EEPROM is lost, and then the VFD will display “FACT LOST”.

Exception handling

If the power supply cannot start normally, please check and take measures by reference to steps below.

1. Check whether the power cord is correctly connected and confirm whether the power supply is powered.

Correct wiring of power cord => 2

Incorrect wiring of power cord => Re-connect the power cord and check whether the exception is removed.

2. Check whether the power in On. Power key is under “” On status.

Yes => 3

No => Please check the Power key to start power and check whether the exception is removed.

3. Check whether the fuse of power supply is burned out.

If yes, change fuse. Detailed steps:

- 1) Pull out power line and take out the fuse box at power line jack with a small screw driver. As shown below.

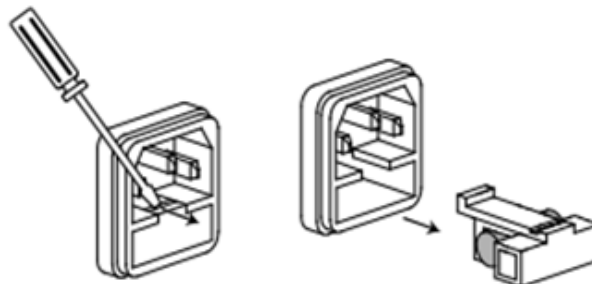

- 2) If the fuse is fused, please change fuse of same specification based on machine model. See the table below for matching information of fuse

and machine model.

Products	Specification (110VAC)		Specification (220VAC)	
IT6922A	T4A	250V	T2A	250V
IT6932A	T6.3A	250V	T3.15A	250V
IT6933A	T6.3A	250V	T3.15A	250V
IT6942A	T10A	250V	T6.3A	250V
IT6952A	T15A	250V	T10A	250V
IT6953A	T15A	250V	T10A	250V
IT6922B	T4A	250V	T2A	250V
IT6932B	T6.3A	250V	T3.15A	250V
IT6942B	T12.5A	250V	T6.3A	250V
IT6952B	T15A	250V	T10A	250V
IT6953B	T15A	250V	T10A	250V

- 3) After replacement, install the fuse box back to original position, as shown below.

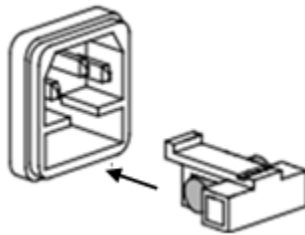

NOTE

Fuse of IT6952A/IT6953A/IT6952B/IT6953B can unscrew directly by hand.

Chapter3 Function and Features

3.1 Local/Remote Mode







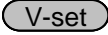



Local button can enable you switch mode from remote to local mode.

After you power on the power supply, unit will default in local mode, all the buttons can be used in this mode. While in remote mode, you can't operate through front panel directly. Local and remote mode can be controlled through PC. In addition, the mode changing will not influence the output parameters.

3.2 Voltage Setup

You can set voltage within the range of rated voltage value. When you press  button, the button will be lit. This indicates that you can set voltage.





There are three ways to set output voltage through front panel.

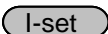



- The first way: press , adjust cursor location through  button, pressing  and  will enable you to adjust the setting voltage value.
- The second way: press , adjust cursor location through  button, adjust rotary knob  to change the setting voltage value.
- The third way: press  button and number key ( to ) to set voltage value.

3.3 Current Setup

You can set current within the range of rated current value. When you press  button, the button will be lit. This indicates that you can set current.

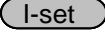
There are three ways to set output current through front panel.

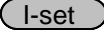
- The first way: press , adjust cursor location through  button, push  and  will enable you to adjust the setting current value.

- The second way: press , adjust cursor location through  button, adjust rotary knob  to change the setting current value.
- The third way: press  button and number key( to ) to set current value.

3.4 On/Off Operation

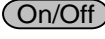
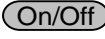
 button is used to control the output state of power supply. When  button is lit, this indicates the output is in on mode. When output is open, the working state indicator light(CV/CC) will be lit.

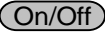
Note: make sure you have connected power supply well, then press  button.

3.5 Setup value/Actual value

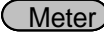
You can switch the display between setting value and actual value by pressing  button. When this button is lit, screen displays actual output value and the indicator light “meter” will be lit on the VFD board. In other words, when the button is not lit, the front panel displays setting value.

3.6 Voltage/Current/Power adjustment

The output current value is determined by output voltage of power supply and electronic load’s resistance. Only when the actual current value is lower than the setting current value, can power supply work in CV mode and the will CV indicator light be lit.

If output current is higher than the setting value, then power supply will function in CC mode. And the CC indicator light will be lit.

The output voltage and current value are also influenced by the upper limit of output power. Take IT6932A (60V/10A/200W) for example, suppose you set the max power value to be 200W, then when the setting output voltage and current is 25V/10A, in fact, the unit can only output 25V/8A.

3.7 Saving Operation

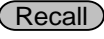
Customer can save some often-used parameters in nonvolatile memory. You can use the button  +  (Save) button or SCPI order *SAV, *RCL to achieve this function. Saving parameters include: setting voltage/setting current

Saving method:

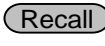
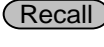
Press  +  (save) button, and then input the group number you want to save through number key board. Press enter button to confirm. If you want to recall the saved parameters, press  button and corresponding group number (number1-9).At last press enter button to confirm.

3.8 Trigger Operation

You need to select the trigger mode from the menu before using this function.

After you edit a list file, press  +  (Trigger) to give a trigger signal.

During the running process,  button will be lit all the time.

3.9 Menu Operation

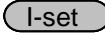
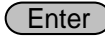
Press  +  (Menu) to enter the menu. You will see a optional items on the screen, through direction keys and rotary knob to upturn VFD display, then the screen will display the following functions .Press  button will enter

corresponding items. Press  button will return to previous menu.

IT6922A/IT6932A/IT6933A/IT6942A/IT6952A/IT6953A power supply menu function is shown as below.

MAX VOLT	Set the max output voltage				
OCF SET	OFF	Disable the over current protection function.			
	ON	Enable the over current protection function.			
SYST SET	P-MEN (RESET)	Reset	Power is restored to factory setting		
		Keep	Set the power-on state as the last power off state		
	P-OUT (OFF)	OFF	Enable the power-on output state to be off mode		
		Keep	Set the power-on output state to be the last power-off output state		
	COMM (GPIB)	GPIB	ADDR	Address can be set within 0-30	
			BAUD	4800	
		9600			
		19200			
		38400			
		57600			
115200					
NONE 8BIT		NONE 8BIT			
	EVEN 8BIT				
	ODD 8BIT				

			MODE	SIGNAL		
				MUX	ADDR. Address can be set within 0-30	
			USB			
BEEP (ON)	OFF		Close the key sound			
	ON		Open the key sound			
KNOB (ON)	LOCK		Lock the rotary knob function			
	ON		Unlock the rotary knob function			
TRIG (MANUAL)	MANU		Local keyboard trigger			
	BUS		External trigger			
MEM (GROUP1)	GRP1-8		Save and recall operation			
ADC SPEED	SLOW		AD speed is low speed			
	MID		AD speed is middle speed			
	FAST		AD speed is high speed			
METER RETURN	WAIT 5 S		In the voltage/current setting state (or the LOCK state to view the set value), if there is no operation in 5S, it will automatically return to the measurement state.			
	NO		It does not automatically return to the measurement state.			
TIMER SET	OFF		Close the timer function			
	ON		Open the timer operation, the time can be set within 0.1-99999.9s			
RESET	NO		keep the original setting			
	YES		restore the factory setting			
EXIT			Quit the menu setting			
LIST SET	LIST STATE	OFF	Close list test function			
		ON	Open list test function			
LIST LOAD			Recall the saved list file(FILE0-FILE9)			
LIST EDIT	TIME (SEC)	SEC	second			
		MIN	minute			
	VSET		Setup the single step voltage			
	ISET		Setup the single step current			
	SEC		Setup single step delay time(0.1-9999)			
	NEXT (YES)	YES		continue the edit of next step		
		NO		End up the list file edit		
	REPET	1-65535		Set the cycle time of list file		
	SAVE	NO		Do not save the current list file		
		FILE0-FILE9		Save the list file to appointed document		
EXIT			Quit the system menu			
POWER INFO	MODEL		Unit model			
	VER		The software version			
	SN-1		The first six number of SN			

	SN-2	The middle six number of SN
	SN-3	The last six number of SN
	EXIT	Quit the information menu
EXIT MENU	Quit the main menu	

IT6922B/IT6932B/IT6942B/IT6952B/IT6953B power supply menu function is shown as below.

MAX VOLT	Set the max output voltage				
OCF SET	OFF	Disable the over current protection function.			
	ON	Enable the over current protection function.			
SYST SET	P-MEN (RESET)	Reset	Power is restored to factory setting		
		Keep	Set the power-on state as the last power off state		
	P-OUT (OFF)	OFF	Enable the power-on output state to be off mode		
		Keep	Set the power-on output state to be the last power-off output state		
	COMM (GPIB)	GPIB	ADDR	Address can be set within 0-30	
			RS232	BAUD	4800
					9600
					19200
					38400
					57600
		115200			
		NONE 8BIT	NONE 8BIT		
			EVEN 8BIT		
			ODD 8BIT		
		MODE	SIGNAL		
			MUX	ADDR. Address can be set within 0-30	
		COM (GPIB)	USB		
			RS485	BAUD	4800
					9600
	19200				
	38400				
	57600				
	115200				
NONE 8BIT	NONE 8BIT				
	EVEN 8BIT				
	ODD 8BIT				
MODE	SIGNAL				
	MUX		ADDR. Address can be set within 0-30		
BEEP (ON)	OFF	Close the key sound			
	ON	Open the key sound			

	KNOB (ON)	LOCK	Lock the rotary knob function		
		ON	Unlock the rotary knob function		
	Ext-C	OFF	Disable external signal control function		
		ANA	Enable external analog control function		
		DIGIT	Enable external digital control function		
	TRIG (MANUAL)	MANU	Local keyboard trigger		
		BUS	External trigger		
	MEM (GROUP1)	GRP1-8	Save and recall operation		
	ADC SPEED	SLOW	AD speed is low speed		
		MID	AD speed is middle speed		
		FAST	AD speed is high speed		
	METER RETURN	WAIT 5 S	In the voltage/current setting state (or the LOCK state to view the set value), if there is no operation in 5S, it will automatically return to the measurement state.		
		NO	It does not automatically return to the measurement state.		
	TIMER SET	OFF	Close the timer function		
		ON	Open the timer operation, the time can be set within 0.1-99999.9s		
	RESET	NO	keep the original setting		
		YES	restore the factory setting		
	EXIT	Quit the menu setting			
	LIST SET	LIST STATE	OFF	Close list test function	
			ON	Open list test function	
LIST LOAD		Recall the saved list file(FILE0-FILE9)			
LIST EDIT		TIME (SEC)	SEC	second	
			MIN	minute	
		VSET	Setup the single step voltage		
		ISET	Setup the single step current		
		SEC	Setup single step delay time(0.1-9999)		
		NEXT (YES)	YES	continue the edit of next step	
			NO	End up the list file edit	
		REPET	1-65535	Set the cycle time of list file	
		SAVE	NO	Do not save the current list file	
			FILE0-FILE9	Save the list file to appointed document	
EXIT		Quit the system menu			
POWER INFO		MODEL	Unit model		
	VER	The software version			
	SN-1	The first six number of SN			
	SN-2	The middle six number of SN			
	SN-3	The last six number of SN			
	EXIT	Quit the information menu			

EXIT MENU	Quit the main menu
------------------	--------------------



NOTE

Pressing  button can enable you to quit any function setting.

Maximum voltage set (>MAX VOLT)

The range of setting voltage is from 0V to rated voltage. You can press  +

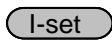
 (Menu) button to enter the menu, then press direction key to

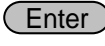
select >MAX VOLT item. Press  button to confirm. After you set the max voltage value, the output voltage value can only be set less than the max voltage. Our default max voltage value is the rated value.

Power-on parameters set (>P-MEN)

This item can set power on state of parameters. If you select RESET item, then all the parameters will be initialized to the factory setting. Output voltage and current will always be 0V/0A. Or the output value will be the same with last power off state. The default setting is RESET item.

Power On Output State (>P-OUT)

This item can set the power on output state. If you select **keep** item, that indicates the power on output state is the same with last power off output state. If you select **off** item, unit will automatically in off mode when you power on. Default setting is **OFF** item.

Communication (>COMM)

Our unit has provided three standard communication interfaces: RS232/USB/GPIB. In this option, you can select the communication interface according to your demands. The range of GPIB address is 0-30. Besides, we have multi-baud rate to be chosen in RS232 mode---4800,9600,19200,38400,57600,11.52K. Data bit is 8, Check digit have three choices: NONE, ODD, EVEN. Before you begin to carry out communication, please make sure the configure in our unit agrees with PC configure.

Key Sound Set (>BEEP ON)

This item can set the key sound state. If in on mode, then key sound will be there when you press buttons. If in off mode, the beeper will not make a sound. The default set is in on mode.

Rotary Knob Set (>KNOB)



This item is used to set rotary knob state. In on mode, you can use this rotary knob to set the output value and overturn the menu items. In lock mode, this knob can't be used. The default setting is in on mode.

External Signal Control Function (>Ext-C) (IT6922B/IT6932B/IT6942B/IT6952B/IT6953B Specific function)

This item is used to enable or disable signal control. When OFF is selected, function is disabled; when ANA (analog control) is selected, external analog control function is enabled; when DIGIT (digit control) is selected, external digit control function is enabled. The default set is in OFF option. This function will be described in details below.



Trigger mode (>TRIG)



Before you running a list file, you need a trigger signal. Thus you must set the trigger mode firstly, in keyboard trigger mode or in external trigger mode. In

MANU trigger mode, press  +  button can generate a trigger signal. In BUS trigger mode, you can only through sending orders to trigger. The default set is MANU option.

Group Set (MEM GROUP)

Power supply can save some often-used parameters in a nonvolatile memory (capacity is 9*8 groups). This function can make the operations more convenient. Customer can save and recall parameters quickly.

GRP1: This indicates saving power supply parameters in 1-9 groups. Press  +  (Save) and the group number (1-9) can save the parameters in corresponding groups.

GRP2: This indicates saving the parameters in 10-18 groups. Press  +  (Save)+saved group number(1-9) can save related parameters. Note that the current number "1" represents parameters are saved in 10th groups. Number "2" represents the parameters are saved in 11th groups.

GRP3-GRP8 by parity of reasoning.

AD Speed Set (>ADC SPEED)

This item is used to set the AD speed, i.e., measurement display speed of power supply. There are three kinds of AD speed, including SLOW, MID and FAST. **Ex-factory set is in SLOW option.**

NOTE

When AD speed of power supply is set to MID or FAST, the measurement accuracy is too low to reach the middle accuracy in the specification. Only when AD speed of power supply is set to SLOW can the middle accuracy in the specification be reached.

Timer Set (>TIMER SET)



This item is used to set the “time on- load” function. In ON mode, the indicator light “Timer” will be lit on the VFD screen. When output of power supply is opened, timer will begin to work, after reaching the definite time, output will be off automatically. If in OFF mode, the timer function will not be enabled. The default set is in OFF option.

Reset (>RESET)

This item is used to reset all items in the menu. If you select >YES, then unit will be restored to factory setting. If you select >NO, all setting in the menu will remain unchanged.



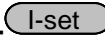

List Mode (>List Set)

Before you edit a list file, please set the trigger mode: manual mode.



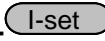



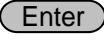
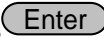

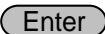













Press  +  button to enter the menu, then press direction key to select >SYST SET option, after that please push  button to confirm. At last please press direction key to select >Trig MANUAL and push  button to confirm.







You can make the output change order by editing every step value of list operation. The parameters you need to edit includes: single-step voltage, single-step current, single-step delay time and whether to go on the next step. Besides, you also need to set the repeat times and save list sequence file. After you finish the editing process, at this time if you receive a trigger signal, power supply will begin to work according to the sequence steps you’ve edited. Now we take five steps for an example:

Operation steps:

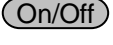
1. Press  +  (Menu) button to enter the menu
2. VFD display >MAX VOLT, press  to select >LIST SET, press  to confirm
3. VFD display >LIST STATE, press  to select >LIST EDIT, press  to confirm
4. VFD display >TIME SEC, press  to confirm, go to the next step,

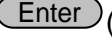
you can also through  button to select **>TIME MIN** time unit, press  to confirm.

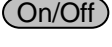
5. VFD display **>VSET 0.000**, press number key  to  or through rotary knob to set voltage, after that press  to confirm.
6. VFD display **ISSET 0.0000**, press number key  to  or rotary knob to set the single-step current, press  to confirm.
7. VFD display **SET 0.1**, press number key  to  or rotary knob to set single-step delay time, press  to confirm.
8. VFD display **NEXT >YES**, press  to confirm.
9. Repeat the steps from 5) to 8) and set the four steps' voltage/current and delay time separately. When screen display **NEXT>YES** in the fourth step edit process, please press  to select **NEXT >NO**, press  to confirm.
10. VFD display **REPET 1**, press number key  to  or rotary knob to set the repeat times, press  to confirm.
11. VFD display **SAVE >NO**, press  to confirm, in this circumstance, the list file is not saved but can run for one time, or you can press  button to select **>SAVE FILE0**, saving the list test file in FILE0~FILE9, press  to confirm. You can recall the file in the following utilization.
12. If you do not save the list test file, VFD will display **LIST EDIT**; if you select to save the test file, VFD will display **SAVE DONE** for three seconds, and then display **LIST EDITL**.
13. Press  to select **>LIST STATE item**, press  to confirm.
14. VFD display **LIST >OFF**, press  to select **>LIST >ON**, press  to confirm. Now  button will be lit. This indicates that list operation function has been opened.

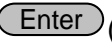
15. VFD display >**LIST STATE**, pressing  button can quit the operation.
16. Press  button to open the output, press  +  (Trigger) to give a trigger signal.
17. If you have edited several list files, you can select **LIST LOAD** item to recall the file you need. And then press  to quit this operation. Press  button to open the output. Now you only need to press  +  (Trigger) to give a trigger signal, the list file can be ran.
18. In LIST mode, voltage set and current set button can't be used, In **LIST STATE** item, choose **LIST>OFF** will enable you to quit list mode.

3.10 OVP Function

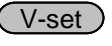
IT6900 series power supply provide OVP function, press  +  button can enable you to set the over voltage protection value. Over voltage may caused by internal defect or customer's incorrect operation(such as output voltage rising),or external voltage too high. Once power supply is protected(OVP), the output will be off immediately and "OVP" indicator light will be lit, the VFD display "OVER VOLT".

Avoid external voltage that across the output terminals exceeding the 120% of rated voltage or it will damage out power supply!

When power supply in OVP state, please check the external factors first, after you exclude the external factors, press ON/OFF button to open output again. If in communication state originally, you should by sending order OUTP ON order to open output.

3.11 Key Lock

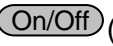
Press  +  (Lock) button to set the key lock state. If keyboard has been locked, the indicator light LOCK will display on the VFD screen. In addition, when key board are lock, all buttons can't be used but ON/OFF, Meter button, shift button. Press this button once again will relieve key lock function.

3.12 Rear Pins Function

3.12.1 Remote sense and DVM terminals

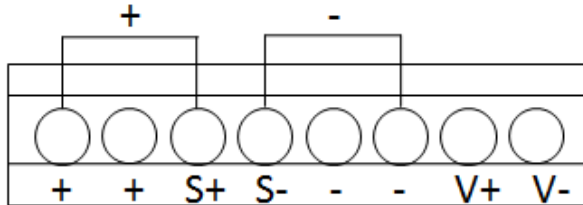

- +, - : output terminals, the same with front panel output terminals.
- S+, S-: remote sense pins.
- V+, V-: the output interface of a four semi-digital voltmeter.

Digital Volt Meter (DVM)

IT6900 series power supply has four semi-digital voltmeter. This DVM can measure 0.001V to 61.000V voltage. Press  +  (DVM) button can enable the measured value display on the VFD screen. Press any key to quit the display of this value.

Remote sense function

Remote sense can adjusted at the output voltage of the device under test, this feature allows to compensate the voltage drop on the wire between the front panel terminals of the power supply and the device under test.

- **Use local sense:**

Local sense doesn't compensate the voltage drop on the connection wire, the operation is:

1. Use the short clips on the back panel of the instrument, or install wire between + and S+, - and S-.
2. Connect the positive and negative terminals of the front panel to the device under test.

- **Use remote sense:**

Remote sense compensate the voltage drop on the connection wire, the operation is:

1. Disconnect the wires/short clips between + and S+, - and S-.
2. Connect wires from S+, S- to the device under test.
3. Connect wires from +, - to the device under test.

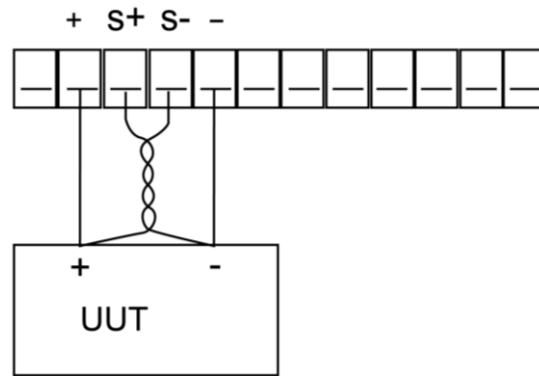

NOTE

In order to ensure the stability of the system, using armored twisted pair cable between the remote sense terminal of IT6900 and load.

Please note that the positive and negative polarity when wiring, otherwise it will damage the instrument!

3.12.2 RS485 and Output Sync signal interface

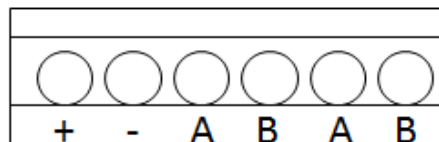
Terminals on IT6922B/IT6932B/IT6942B/IT6952B/IT6953B power supply rear board comprise Output Sync signal interface and RS485 communication interface, as shown below.



- +,-: Output Sync signal terminal
- A, B: RS485 communication interface

DC source output indication function:

There is a Output Sync terminal which is used to indicate the output state of DC source at the rear panel. When in output on mode, Output Sync terminal will output a high level. When in off mode, Output Sync terminal will output a low level.

RS485 communication interface

RS485 communication interface is often used for multiple devices control.

Press  shift + I-set button to entry into the menu, user need to set the parameters of Baud rate, Data bit, Stop bit, parity bit and address, the setting is the same with RS232 communication setting.

3.13 Analog Control Interface

IT6922B/IT6932B/IT6942B/IT6952B/IT6953B power supply output can be controlled and monitored by external DC voltage source (0~10V).

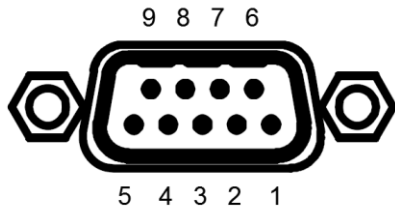

If external analog control is not used, it must be disabled before normal front panel operation can resume. Follow the steps below to enable or disable external analog control. (Entry into the system menu---Enter button to confirm-----select Ext-C item---choose ANA item and enable this mode. If choose DIGIT, it means enable the external digital control function.)

Pin #	Label	Description
1	REF_10V	10V DC reference output
2	Vs/D0	Composite terminal: Voltage programming input/ Digital D0 input terminal
3	Is/D1	Composite terminal: Current programming input/ Digital D1 input terminal
4	D2	Digital D2 input terminal
5	ON/OFF	Control output state
6	Vm	Voltage monitoring output
7	Im	Current monitoring output
8	NULL	None
9	GND	Ground pin

Chapter4 Remote Operation Mode

IT6900A series power supply has three standard communication interface: RS232, USB, GPIB, and IT6900B series power supply has four standard communication interface: RS232, USB, GPIB, RS485. The user can choose any one of them to implement a communication with the computer.

4.1 RS232 interface

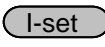
There is a DB9 connector at the rear of the power supply, when connect to computer, you need to connect a cable with COM port on both side. To active connection, you need to set the front panel composite key  +  key configuration settings the same as computer configuration settings. RS-232 interface can be used to program all of the SCPI orders.

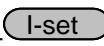

NOTE

The RS232 settings must match the settings in front panel system information. If any change, please press  +  key.

RS-232 data format

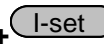
RS-232 data is a 10-bit words which has a start bit and a stop bit. The start bit and stop bit cannot be edited. However, you can select the parity items with  +  key on the front panel. Parity options are stored in nonvolatile memory.

Baud Rate

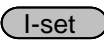
The front panel  +  button allows the user to select a baud rate which is stored in the non-volatile memory: 4800 /9600/ 19200 /38400/ 57600 /115200.

RS-232 connection cable

Use a RS232 cable with DB-9 interface, RS-232 serial port can connect with the controller (e.g. PC). Do not use blank Modem cable.

If your computer is using a RS-232 interface with DB-25 connector, you need an adapter cable with a DB-25 connector at one end and the other side is a DB-9(not blank modem cable)

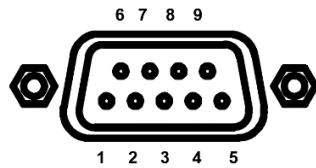

RS232 Pins of Plug

Base pin number	Description
1	No conjunction
2	TXD, data transmission
3	RXD, data receiving
4	No conjunction
5	GND, grounding
6	No conjunction
7	CTS, clear to send
8	RTS, request to send
9	No conjunction

RS-232 Troubleshooting:

If there is RS-232 connection problem, check the following:

- Computer and power supply must configure the same baud rate, parity, data bits and flow control options. Note that the power configuration as a start bit and a stop bit (these values are fixed).
- As described before in RS-232 connector, you must use the correct interface cable or adapter. Note that even if the cable has the right plug, the internal wiring may be wrong.
- Interface cable must be connected to the correct serial port on the computer (COM1, COM2, etc.).

Communication Settings

Before communication, you should first make the following parameters of power supply and PC matches.

Baud Rate: 9600 (4800,9600,19200,38400,57600,115200). You can enter the system menu from the front panel, and then set the baud rate.

Calibration (none, even, odd)

EVEN 8 data bits, have even parity

ODD 8 data bits have odd parity

NONE 8 data bits, no parity

Mode: SIGNAL, MUX

SIGNAL (Single connection mode)

MUX (Multiple connection mode) ADDR: Local address (0 to 30, the factory default setting is 0)

Start Bit	8 Data Bits	Parity=None	Stop Bit
-----------	-------------	-------------	----------

4.2 USB interface

Use a Cable with two USB port to connect the power and the computer. All power functions can be programmed via USB.

The USB488 interface functions of the power supply described as below:



- Interface is 488.2 USB488 interface.
- Interface Receiver REN_CONTROL, GO_TO_LOCAL, and LOCAL_LOCKOUT request.
- Interface receive MsgID = TRIGGER USBTMC order information, and will pass TRIGGER order to the functional layer.

Power USB488 device functions described as follows:

- Devices can read all of the mandatory SCPI orders.
- Device is SR1 enabled.
- Device is RL1 enabled.
- Device is DT1 enabled.

4.3 GPIB interface

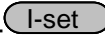
First, Connect the GPIB interface on the power supply and the GPIB card on computer via IEEE488 bus, must be full access and tighten the screws. Then set the address, the address range of the power : 0 to 30,

can set by the function key on the front panel, press the  +  key to enter the system menu function, find the GPIB address setting by  button, type the address,  key to confirm. GPIB address is stored in nonvolatile memory line.

4.4 RS485 interface

IT6922B/IT6932B/IT6942B/IT6952B/IT6953B power supply, via the RS485 interface, provides multi-unit control function for up to 30 units (If connecting more than 10 units, add a 120Ω resistor terminator to the last unit). On the front

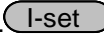
panel, press  (Shift)+  keys to enter into the system menu, and the related setting is the same as the RS232 communication setting.

User can set the following parameters of the RS485 interface:

Baud rate: 9600(4800/9600/19200/38400/57600/115200)

Parity and data bit: NONE/8BIT, EVEN/8BIT, ODD/8BIT

EVEN	8 data bits, have even parity
ODD	8 data bits have odd parity
NONE	8 data bits, no parity

Mode: SIGNAL (Single connection mode)

MUX (Multiple connection mode) ADDR: Local address (0 to 30, the factory default setting is 0)

Start Bit	8 Data Bits	Parity=None	Stop Bit
-----------	-------------	-------------	----------

To set the multi-unit connection mode, access the system Menu→SYST SET→COMM→RS485→MODE→MUX, to turn on the chain mode.

Set each unit with a different Address (0 to 30). Then by using RS485, connect the first power supply in the chain to a PC. Now, multiple units daisy-chained via RS485 can be controlled by one PC by using the commands specific for multi-unit connection. See “Programming Guide” section for details.

The figure below is a schematic diagram of the connection of 4 machines.

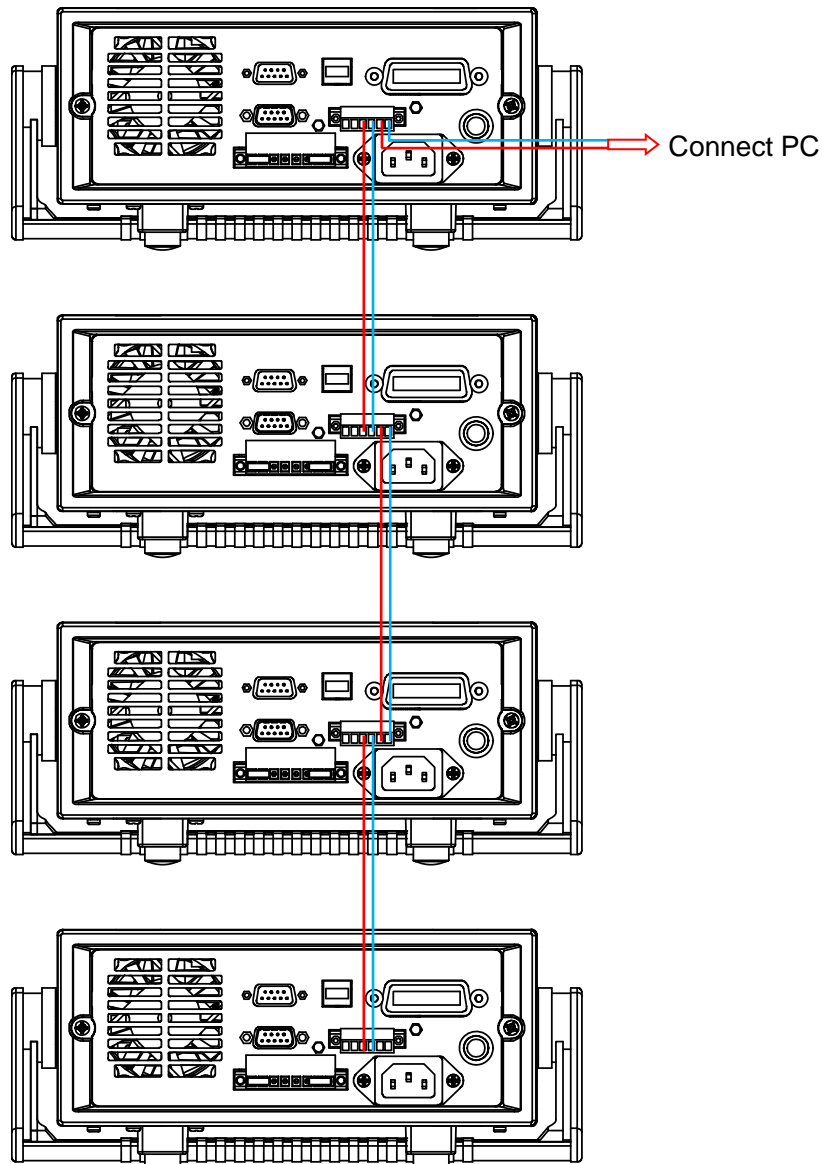

Chapter5 Technical Specification

This chapter will introduce the main technical parameters of IT6900, such as rated voltage/current/power and so on. Besides, we will introduce the working environment and storage temperature.

5.1 Major Technical Parameters

Parameters		IT6922A	IT6932A	IT6942A
Rated values (0 °C~40 °C)	voltage	0~60V	0~60V	0~60V
	current	0~5A	0~10A	0~15A
	Power	100W	200W	360W
Load regulation ±(%of output+offset)	voltage	≤0.01%+3mV	≤0.01%+10mV	≤0.01%+30mV
	current	≤0.05%+2mA	≤0.05%+4mA	≤0.05%+6mA
Line regulation ±(%of output+offset)	voltage	≤0.01%+3mV	≤0.01%+10mV	≤0.01%+30mV
	current	≤0.05%+2mA	≤0.05%+4mA	≤0.05%+6mA
Setup resolution	voltage	1mV	1mV	1mV
	current	0.1mA	1mA	1mA
Readback resolution	voltage	1mV	1mV	1mV
	current	0.1mA	1mA	1mA
Setup accuracy (within twelve months) (25°C±5°C) ±(%of output+offset)	voltage	≤0.03%+5mV	≤0.03%+5mV	≤0.03%+5mV
	current	≤0.1%+5mA	≤0.1%+10mA	≤0.1%+15mA
Read back resolution (W) (25°C±5°C) ±(%of output+offset)	voltage	≤0.03%+5mV	≤0.03%+5mV	≤0.03%+5mV
	current	≤0.1%+5mA	≤0.1%+10mA	≤0.1%+15mA
Ripple (20Hz ~20MHz)	voltage	≤5mVp-p	≤8mVp-p	≤15mVp-p
	current	≤5mArms	≤6mArms	≤8mArms
Sample rate	10HZ			
Dimension (mm)	214.5mmW×88.2mmH×354.6mmD			
Weight (net)	7.7Kg			

Parameters		IT6933A
Rated values (0 °C~40 °C)	voltage	0-150V
	current	0-5A
	Power	200W
AC Input	voltage	220VAC ±10%/110VAC ±10%
	Frequency	47 Hz ~63Hz
Maximum input current	2A	
Maximum input apparent power	500VA	
Efficiency	0.55	
Power Factor	0.7	
Load regulation ±(%of output+offset)	voltage	≤0.01%+20mV
	current	≤0.01%+6mA
Line regulation ±(%of output+offset)	voltage	≤0.01%+20mV
	current	≤0.01%+6mA
Setup resolution	voltage	1mV(<100V), 10mV(≥100V)
	current	0.1mA
Readback resolution	voltage	1mV(<100V), 10mV(≥100V)
	current	0.1mA
Setup accuracy (within twelve months) (25°C±5°C) ±(%of output+offset)	voltage	≤0.04%+30mV
	current	≤0.1%+10mA
Read back resolution (W) (25°C±5°C) ±(%of output+offset)	voltage	≤0.04%+30mV
	current	≤0.1%+10mA
Ripple(20Hz ~20MHz)	voltage	≤30mVp-p
	current	≤6mArms
Rise time(No-load)	voltage	200ms
Rise time(Full-load)	voltage	300ms
Fall time(No-load)	voltage	2s
Fall time(Full-load)	voltage	150ms
Transient Response Time	200us	
Remote Sense Compensation	1V	
Command Response Time	10~600ms	
Difference-mode voltage(Vpp)	50mV	
Difference-mode current (Arms)	20mA	
Setup Temp.coefficient (0 °C~40 °C)	voltage	50 PPM/°C +30mV
	current	50 PPM/°C+30mA

Readback Temp.coefficient (0 °C~40 °C)	voltage	50 PPM/°C+30mV
	current	50 PPM/°C+30mA
Working temperature	0-40°C	
Storage temperature	-10-70°C	
Series number	2	
Parallel number	2	
Isolation(output to ground)	240V	
Dimension (mm)	214.5mmW×88.2mmH×354.6mmD	
Weight (net)	7.7Kg	

Parameters		IT6952A	IT6953A
Rated values (0 °C~40 °C)	voltage	0~60V	0~150V
	current	0~25A	0~10A
	Power	600W	600W
Load regulation ±(%of output+offset)	voltage	≤0.01%+30mV	≤0.01%+25mV
	current	≤0.1%+10mA	≤0.05%+10mA
Line regulation ±(%of output+offset)	voltage	≤0.01%+30mV	≤0.01%+25mV
	current	≤0.1%+10mA	≤0.05%+10mA
Setup resolution	voltage	1mV	1mV(<100V) 10mV(>100V)
	current	1mA	1mA
Readback resolution	voltage	1mV	1mV(<100V) 10mV(>100V)
	current	1mA	1mA
Setup accuracy (within twelve months) (25°C±5°C) ±(%of output+offset)	voltage	≤0.03%+5mV	≤0.03%+20mV
	current	≤0.1%+25mA	≤0.1%+25mA
Read back resolution (W) (25°C±5°C) ±(%of output+offset)	voltage	≤0.03%+5mV	≤0.03%+20mV
	current	≤0.1%+25mA	≤0.1%+25mA
Ripple (20Hz ~20MHz)	voltage	≤20mVp-p	≤50mVp-p
	current	≤15mArms	≤15mArms
Sample rate	10HZ		
Dimension (mm)	214.5mmW×88.2mmH×445mmD		
Weight (net)	15Kg		

Parameters		IT6922B	IT6932B
Rated values (0 °C~40 °C)	voltage	0~60V	0~60V
	current	0~5A	0~10A
	Power	100W	200W
Load regulation ±(%of output+offset)	voltage	≤0.01%+3mV	≤0.01%+10mV
	current	≤0.05%+2mA	≤0.05%+4mA
Line regulation ±(%of output+offset)	voltage	≤0.01%+3mV	≤0.01%+10mV
	current	≤0.05%+2mA	≤0.05%+4mA
Setup resolution	voltage	1mV	1mV
	current	0.1mA	1mA
Readback resolution	voltage	1mV	1mV
	current	0.1mA	1mA
Setup accuracy (within twelve months) (25°C±5°C) ±(%of output+offset)	voltage	≤0.03%+5mV	≤0.03%+5mV
	current	≤0.1%+5mA	≤0.1%+10mA
Read back resolution (W) (25°C±5°C) ±(%of output+offset)	voltage	≤0.03%+5mV	≤0.03%+5mV
	current	≤0.1%+5mA	≤0.1%+10mA
Ripple (20Hz ~20MHz)	voltage	≤5mVp-p	≤8mVp-p
	current	≤5mArms	≤6mArms
Sample rate	10HZ		
Dimension (mm)	214.5mmW×88.2mmH×354.6mmD		
Weight (net)	7.7Kg		

Parameters		IT6942B	IT6952B
Rated values (0 °C~40 °C)	voltage	0~60V	0~60V
	current	0~15A	0~25A
	Power	360W	600W
Load regulation ±(%of output+offset)	voltage	≤0.01%+30mV	≤0.01%+30mV
	current	≤0.05%+6mA	≤0.1%+10mA
Line regulation	voltage	≤0.01%+30mV	≤0.01%+30mV

Parameters		IT6942B	IT6952B
\pm (%of output+offset)	current	$\leq 0.05\%+6\text{mA}$	$\leq 0.1\%+10\text{mA}$
Setup resolution	voltage	1mV	1mV
	current	0.1mA	0.1mA
Readback resolution	voltage	1mV	1mV
	current	0.1mA(<10A) 1mA(>10A)	0.1mA(<10A) 1mA(>10A)
Setup accuracy (within twelve months) (25°C±5°C) \pm (%of output+offset)	voltage	$\leq 0.03\%+5\text{mV}$	$\leq 0.03\%+5\text{mV}$
	current	$\leq 0.1\%+15\text{mA}$	$\leq 0.1\%+25\text{mA}$
Read back resolution (W) (25°C±5°C) \pm (%of output+offset)	voltage	$\leq 0.03\%+5\text{mV}$	$\leq 0.03\%+5\text{mV}$
	current	$\leq 0.1\%+15\text{mA}$	$\leq 0.1\%+25\text{mA}$
Ripple (20Hz ~20MHz)	voltage	$\leq 15\text{mVp-p}$	$\leq 20\text{mVp-p}$
	current	$\leq 8\text{mA}_{\text{rms}}$	$\leq 15\text{mA}_{\text{rms}}$
Rise time	voltage	$\leq 150\text{mS}(10\%-90\%)$	$\leq 150\text{mS}(10\%-90\%)$
Fall time	voltage	$\leq 2\text{S}(10\%-90\%)$	$\leq 2\text{S}(10\%-90\%)$
Sample rate	10HZ/S		10HZ/S
Dimension (mm)	214.5mmW×88.2mmH×354.6mmD		214.5mmW×88.2mmH× 445mmD
Weight (net)	7.7Kg		15Kg

Parameters		IT6953B
Rated values (0 °C~40 °C)	voltage	0~150V
	current	0~10A
	power	600W
Load regulation \pm (%of output+offset)	voltage	$\leq 0.01\%+25\text{mV}$
	current	$\leq 0.5\%+10\text{mA}$
Line regulation \pm (%of output+offset)	voltage	$\leq 0.01\%+25\text{mV}$
	current	$\leq 0.5\%+10\text{mA}$
Setup resolution	voltage	1mV(<100V) 10mV(≥100V)
	current	0.1mA
Readback resolution	voltage	1mV(<100V) 10mV(≥100V)
	current	0.1mA
Setup accuracy (within twelve months) (25°C±5°C) \pm (%of output+offset)	voltage	$\leq 0.03\%+20\text{mV}$
	current	$\leq 0.1\%+25\text{mA}$

Read back resolution (W) (25°C±5°C) ±(%of output+offset)	voltage	≤0.03%+20mV
	current	≤0.1%+25mA
Ripple (20Hz ~20MHz)	voltage	≤50mVp-p
	current	≤15mArms
Rise time	voltage	≤150mS(10%-90%)
Fall time	voltage	≤7S(90%-10%)
Transient Response Time	voltage	0.2mS
Sample rate	10HZ/S	
Dimension(mm)	214.5mmW×88.2mmH×445mmD	
Weight (net)	15Kg	

*The above specifications may be subject to change without prior notice.

5.2 Supplemental Characteristics

State storage capacity: 9×8 Groups

Recommended calibration frequency: once a year

Cooling style: fans

Maximum input power:

Model	Maximum input power	Model	Maximum input power
IT6922A	350VA	IT6942A	1000VA
IT6932A	550VA	IT6952A	2000VA
IT6933A	550VA	IT6953A	2000VA
IT6922B	350VA	IT6932B	550VA
IT6942B	1000VA	IT6952B	2000VA
IT6953B	2000VA	-	-

Appendix

Specifications of Red and Black Test Lines

ITECH provides you with optional red and black test lines, which individual sales and you can select for test. For specifications of ITECH test lines and maximum current values, refer to the table below.

Model	Specification	Cross section	Length
IT-E301/10A	10A	-	1m
IT-E301/30A	30A	6mm ²	1.2m
IT-E301/30A	30A	6mm ²	2m
IT-E301/60A	60A	20mm ²	1.5m
IT-E301/120A	120A	50mm ²	2m
IT-E301/240A	240A	70mm ²	1m
IT-E301/240A	240A	70mm ²	2m
IT-E301/360A	360A	95mm ²	2m

For maximum current of AWG copper wire, refer to table below.

AWG	10	12	14	16	18	20	22	24	26	28
The Maximum current value(A)	40	25	20	13	10	7	5	3.5	2.5	1.7

Note: AWG (American Wire Gage), it means X wire (marked on the wire). The table above lists current capacity of single wire at working temperature of 30°C. For reference only.

Contact Us

Thanks for purchasing ITECH products. In case of any doubts, please contact us as follows:

1. Visit ITECH website: www.itechate.com
2. Select the most convenient contact method, for further information.