

Product

Battery Simulation Test Solution
BSS2000/BSS2000 Pro/BSS2000M

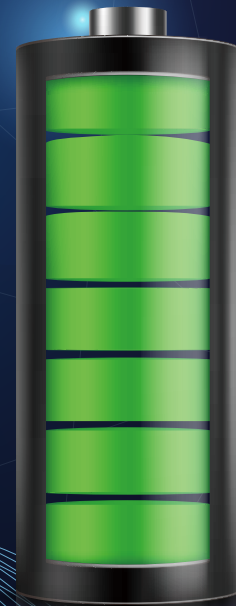
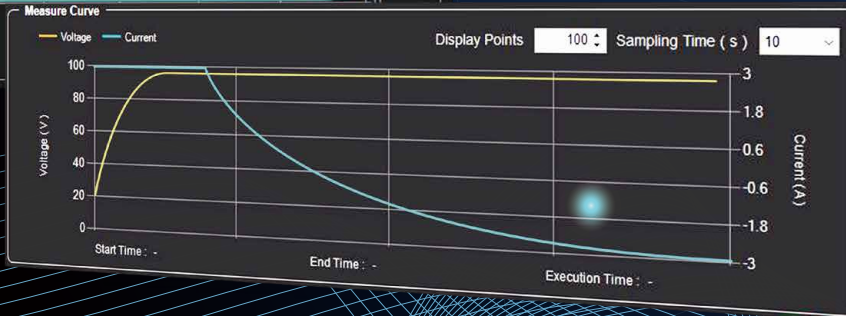

Battery Simulation Test Solution

BSS2000/ BSS2000 Pro/ BSS2000M

Your Power Testing Solution

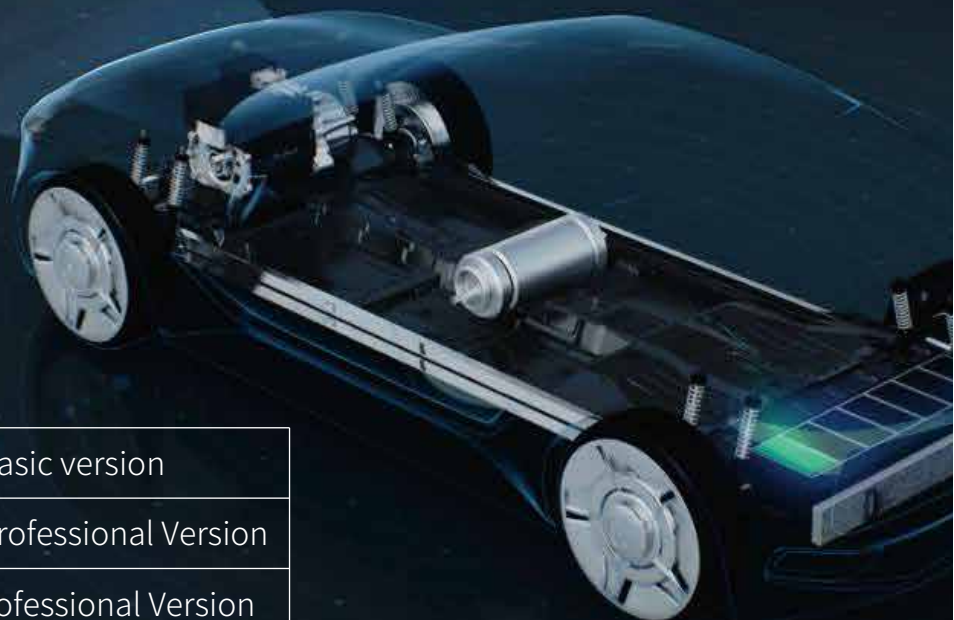
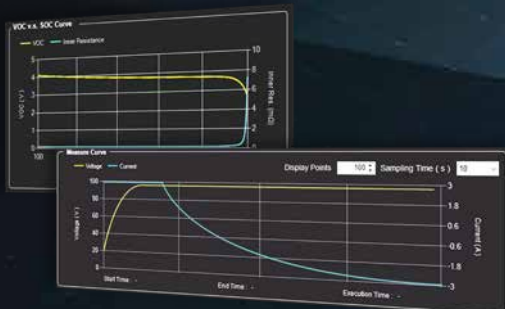

BSS2000	Single channel & Basic version
BSS2000 Pro	Single channel & Professional Version
BSS2000M	Multi-channel & Professional Version

With the development of battery technology, battery weight and energy density are further improved while the cost is reducing, making batteries widely used in new energy vehicles, photovoltaic energy storage and consumer electronics products. In order to fully verify the performance of the product in different SOC states of the battery, engineers need to conduct lots of tests in the early stage of R&D to continuously optimize the product design or select a more suitable battery.

The BSS2000/BSS2000 Pro/BSS2000M battery simulating software are products specifically designed for the above test scenarios. On the one hand, it will solve the problem of increasing cost of buying and storage of different types of batteries; On the other hand, the battery simulator can be quickly set to different state of SoC without real charge and discharge process, greatly improve test efficiency. The advanced version of BSS2000 Pro/BSS2000 M is developed to meet higher level testing requests. Based on the basic version of BSS2000, .mat file importing and more built-in battery types are provided with the Pro version software. Software combined with ITECH's latest high-performance bidirectional DC power supply, IT6000B/IT6000C/IT-M3400/IT-M3600/IT-M3900B/IT-M3900C/IT6600C, covering a power range up to 10MW, can provide users with a wide range simulation solution covering low-power battery module to high-power power battery system simulation.

FEATURE

- Battery simulation range: 2250V/10MW
- Support up to 20ch batteries simulation^{*1}
- Bidirectional regenerative battery simulator, regenerative efficiency up to 95%
- Seamless switching between battery charging and discharging mode
- Support user-defined battery characteristic curve import
- Support quick set up of battery characteristic curves by input common parameters
- Support .mat file import function^{*2}
- Built-in various battery types (include LeadAcid, Li-on, L-MO, LNMCO, LNMCO&LMO, LFP, LTO and NiMH .)^{*3}
- Battery protection parameter setting function
- Initial SoC setting function
- Ideal data report function
- Battery curve preview and real-time curve display function
- Flexible expansion by parallel for larger current/power simulation request

*1 BSS2000M

*2 BSS2000 Pro/BSS2000M

*3 BSS2000 basic version software is used to simulate lead-acid and lithium-ion batteries.

Your Power Testing Solution

BSS2000 Battery Simulation Software

Applications

E-mobility

EV Powertrain testing, DC Charger testing
FCEV PDU power distribution unit testing



Solar PV

Renewable energy storage control unit
test, smart micro grid PCS testing



Others

Aerospace and defense energy storage
battery simulation test and more

Common battery parameters setting and function simulation

By combined various types of battery modelling and high-speed algorithms, BSS2000/BSS2000 Pro/BSS2000M Battery Simulation Software provide the user with real-time battery curve simulation function. No need to know the specific internal characteristics of the battery, the user only needs to select the battery type and the battery characteristic curve can be generated easily by setting a few basic parameters, parameters including full voltage, empty voltage, rated capacity, serial qty, parallel qty and battery internal resistance, etc. Thanks to the strong support of ITECH hardware, the battery simulator can simulate up to 10MW battery packs, covering the test requests of solar PV ,energy storage, EV and other high-power fields.

Full Voltage (V)	12.00
Empty Voltage (V)	8.00
Inner Resistance (mΩ)	1.0
Capacity (Ah)	10.000
Parallel	1
Series	1
I+ (A)	5.00
I- (A)	-5.00
Initial SOC (%)	90.00

User-defined battery characteristic curve

BSS2000/BSS2000 Pro/BSS2000M Battery Simulation Software provides the battery curve simulation function by importing Data to meet the needs of various simulation requests. Users can import the measured battery charge and discharge data in a csv file to simulate the battery charge and discharge characteristic curve. This function is not only suitable for the simulation of conventional batteries, but also for the simulation of some special batteries or novel batteries.

SOC	OCV	R
0	2.654	7.25179
0.1	2.689676	6.28948
0.2	2.724133	5.463998
0.3	2.757411	4.755715
0.4	2.789552	4.147823
0.5	2.820595	3.625931
0.6	2.850577	3.177712
0.7	2.879535	2.792612
0.8	2.907504	2.461595

Your Power Testing Solution

BSS2000 Battery Simulation Software

Support .mat file import function

BSS2000 Pro/BSS2000M

BSS2000 Pro/BSS2000M battery simulation software provides professional battery researchers with the function of importing .mat files, through which users can simulate the corresponding battery characteristic curves under different battery mathematical models. This function is of great significance for the research on the adaptability of new batteries and products, and the application of conventional batteries in special environments. Conventional types of battery characteristic curves or mathematical models are generally based on typical conditions, and for new batteries or applications in special environments, engineers often need to construct new battery mathematical models to more realistically reflect the performance of batteries in specific application contexts. This function is specially developed for such applications. Users can build a new battery mathematical model through a third-party MATLAB * simulation platform and import .mat file into BSS2000 Pro/BSS2000M Pro for simulation, and then verify the battery's adaptability in practical applications.

* MATLAB is a mathematical software developed by MathWorks, USA

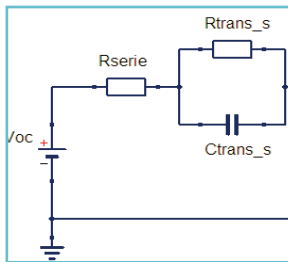

Battery mathematical model

Support .mat file import function

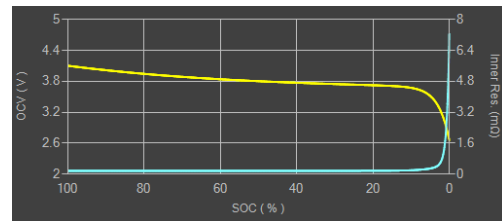

BSS2000 Pro Software

Built-in various batteries types for selection

BSS2000 Pro/BSS2000M

BSS2000 Pro/BSS2000M Battery Simulation Software provides users with unique Modelling functions, by built-in commonly used battery types and characteristic curves into the software. The user only needs to select the battery type and configure the series and parallel parameters to simulate the characteristic curves of battery modules of different types and different capacities. The battery types selectable by BSS2000 Pro include Lion, LMO, LNMCO, LNMCO&LMO, LFP, LTO and NiMH.

* BSS2000 basic version software is used to simulate lead-acid and lithium-ion batteries.

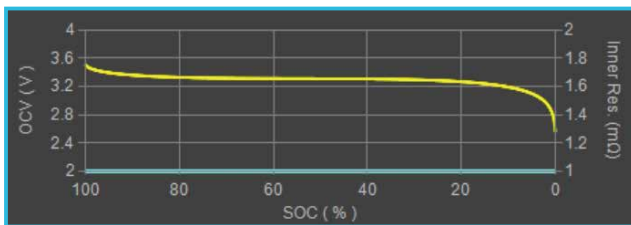
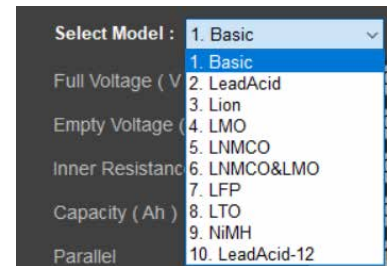

LFP

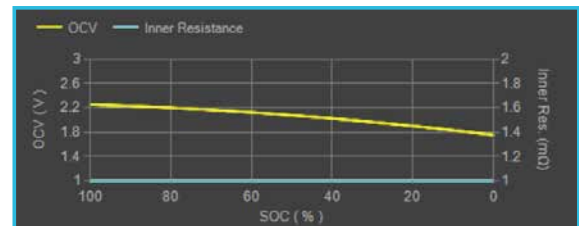

Lead-acid battery

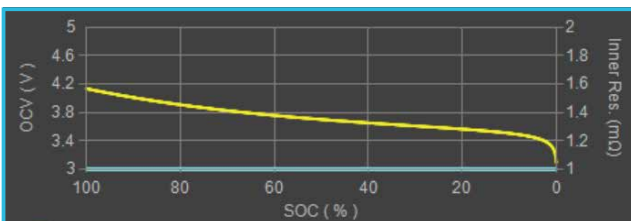

Ternary lithium battery

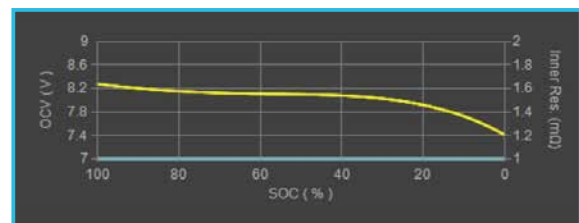

Ni/MH

Initial SoC setting function

The BSS2000/BSS2000 Pro/BSS2000M battery simulation software allows the user to set the initial capacity of the battery to study the startup characteristics or energy management characteristics of DUT when the battery is fully charged or depleted, without the need to perform real charging and discharging, and improve test efficiency.

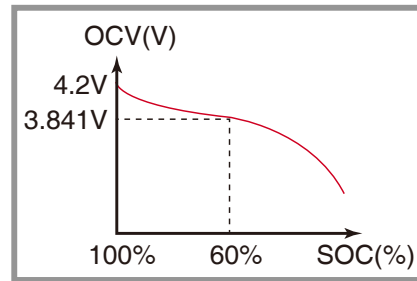

Real-time parameter monitoring

The BSS2000/BSS2000 Pro/BSS2000M battery simulation software provides multi-channel control function and supports preview function of edited curves. Meanwhile, during the test operation, the operating parameters and operating curves of the battery simulator are monitored in real time. In order to facilitate research and test personnel to trace the experimental data, the software provides report generation function, and the saved data includes voltage, current, power, SoC, charge/discharge status, and capacity.

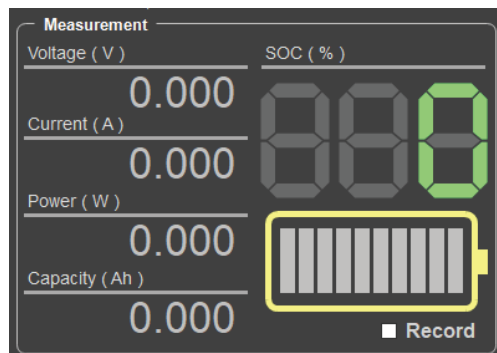

Seamless battery charge / discharge simulation

In real life scenarios, such as the EV field, as the vehicle decelerates, accelerates, or brakes, the battery continuously switches between the two states of discharge and energy recovery. Therefore, the battery simulator also needs to flexibly switch between being charged and discharge status and respond in a timely manner according to external state changes. The BSS2000/BSS2000 Pro/BSS 2000M battery simulator benefits from the hardware advantages of source and load in one device, which can realize the seamless switching between charging and discharging, to simulate the characteristics of the battery more realistically.

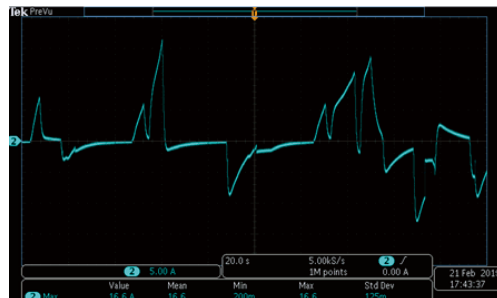

Protection parameter settings

In practical applications, in order to extend the service life of the battery and prevent the battery from overcharge and overdischarge, the BMS (battery management system) in the battery pack will limit the safety range of the battery for different applications. When it is higher or lower than the protection limit value, the software cut down the circuit in time to protect the battery and DUT. BSS2000/BSS2000 Pro/BSS2000M battery simulation software supports multiple protection condition settings: SoC upper/lower alarm value setting, SoC upper/lower protection value setting; OCV upper/lower alarm value setting, OCV upper/lower protection value setting.

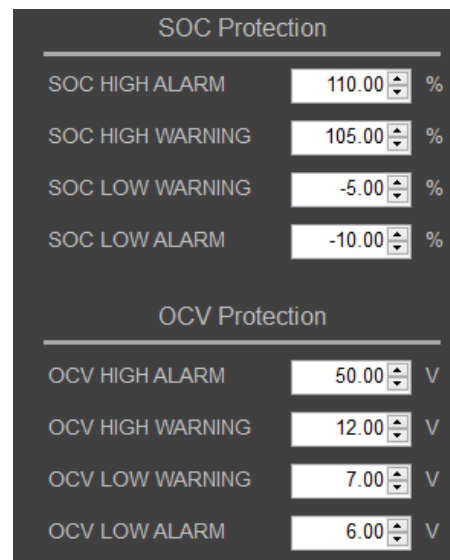

Your Power Testing Solution

BSS2000 Battery Simulation Software

Battery Simulator

Application field 1 -Hydrogen fuel cell vehicle

Test purpose -verify the energy management strategies of fuel cells and lithium-ion battery packs

Mode 1 Power battery and fuel cell systems to power the motor

Mode 2 The fuel cell system powers the motor and charges the power battery at the same time (when the battery SOC is low)

Mode 3 Motor braking energy is feedback to power battery

ITECH solution -BSS2000 Pro & IT6000C/IT6000B/IT6600C

Advantage

- battery simulator can simulate power battery
- battery simulator can realize seamless switching between charging and discharging
- multiple built-in battery types (lithium battery, lithium iron phosphate battery...)

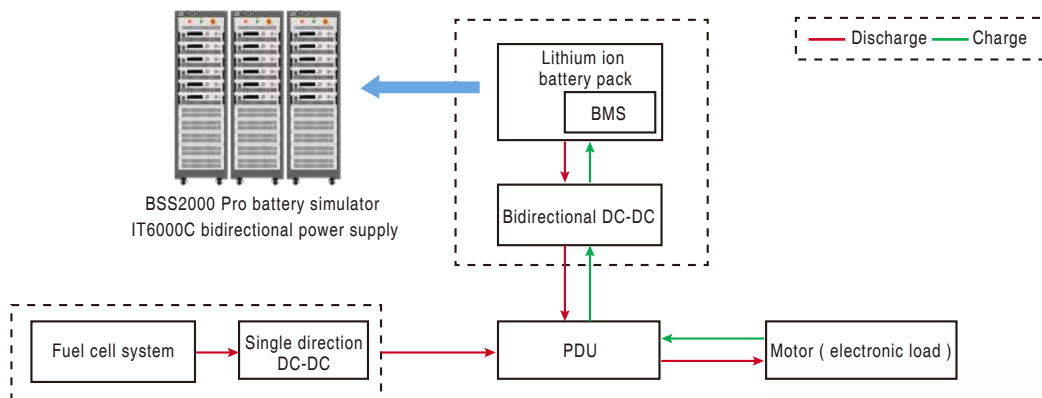
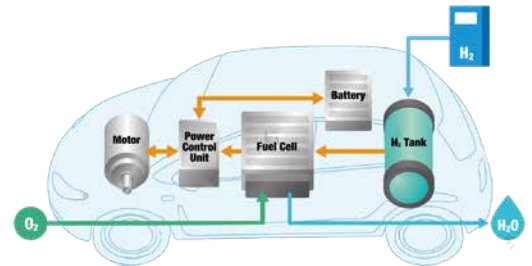

Application field 2 – MCU Test

Test purpose -verify the MCU performance under different SOC

ITECH solution -BSS2000 Pro & IT6000C/IT6000B

Advantage

- arbitrarily specify the initial SOC state of the battery
- verifies the performance of the MCU under the limit state of the battery power
- automatically absorb the reverse EMF of the motor to protect the MCU



BSS2000 battery simulator
IT6000C bidirectional power supply



Your Power Testing Solution

BSS2000 Battery Simulation Software

Application field 3 – Smart grid

Test purpose -Verify the PCS electrical performance of energy storage converter

ITECH solution -BSS2000 Pro & IT6000C/IT6000B/IT6600C

Advantage -max. power of battery simulator is up to 10MW
 -support multiple choices of battery types, including lithium battery, lead-acid battery, etc.

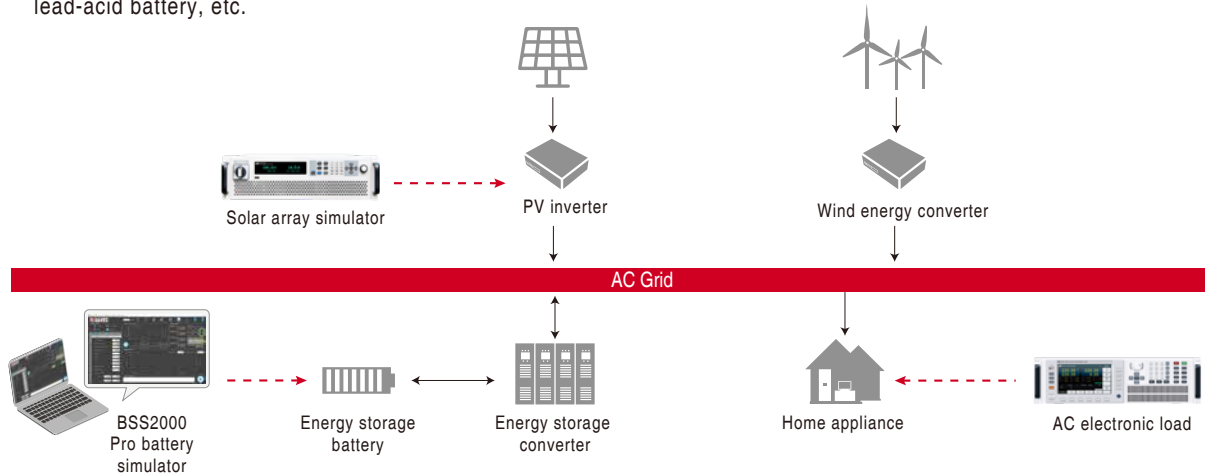

Application field 4- transportation

Test purpose -Research on Energy Distribution of Hydrogen Energy Tram Power System

ITECH solution -BSS2000 Pro & IT6000C/IT6000B/IT6600C

Advantage -user-defined battery characteristic curve
 -supports the import of .mat format files, which is convenient for the performance research of the new kind of battery in the propulsion system
 -real-time display of current battery voltage, current, capacity, energy and SOC

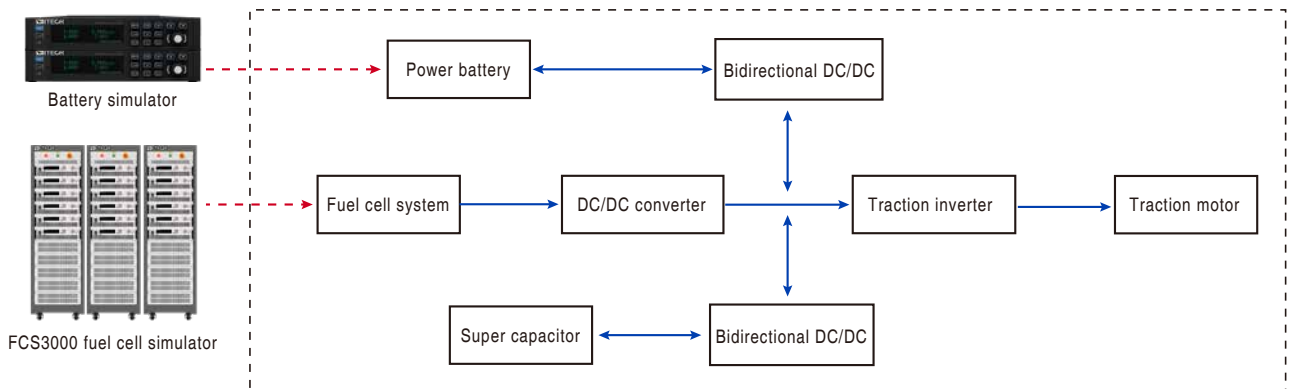

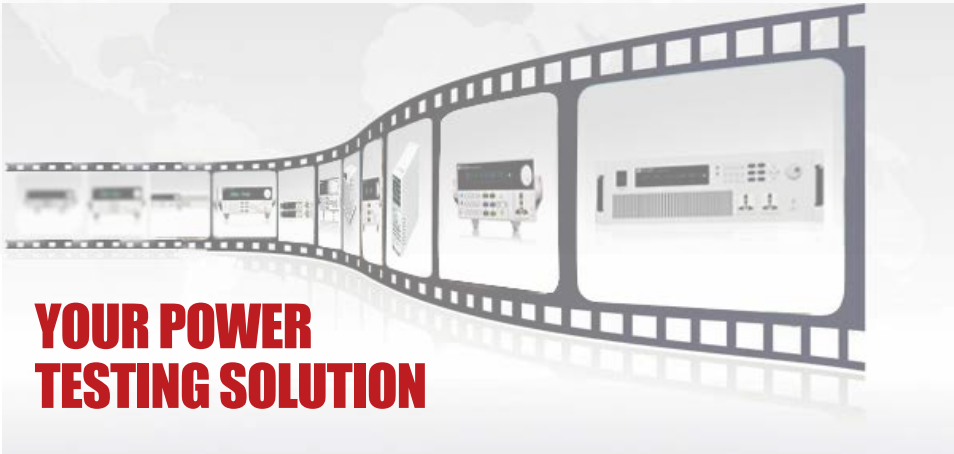

This information is subject to change without notice. For more information, please contact ITECH.

Taipei

Add: No.918, Zhongzheng Rd., Zhonghe Dist., New Taipei City
235, Taiwan
Web: www.itechate.com
TEL: +886-3-6684333
E-mail: info@itechate.com

Factory I

Add: No.108, XiShanqiao Nanlu, Nanjing city, 210039, China
TEL: +86-25-52415098
Web: www.itechate.com

Factory II

Add: No.150, Yaonanlu, Meishan Cun, Nanjing city, 210039, China
TEL: +86-25-52415099
Web: www.itechate.com



ITECH Web



ITECH Facebook



ITECH LinkedIn